

Seamless Bend 45°

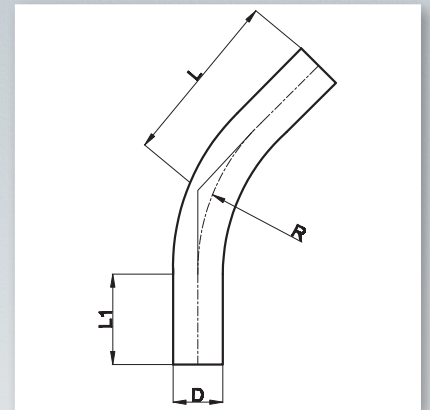

PE100 | SDR 11 | Water PN 16 | Gas 10 Bar

D (mm)	L1 (mm)	R (mm)	L (mm)	Weight (kg)	Box Quantity
50	100	75	170	0.30	1
63	100	95	180	0.40	1
75	100	113	200	0.70	1
90	100	135	220	1.10	1
110	150	165	240	1.70	1
125	150	188	270	2.40	1
140	150	210	300	3.50	1
160	180	240	330	5.00	1
180	188	270	380	7.20	1
200	214	300	430	10.50	1
225	252	338	500	15.90	1
250	262	375	530	19.40	1
280	263	420	550	26.50	1
315	318	473	650	38.80	1
355	301	533	650	49.20	1
400	337	600	730	70.70	1
450	320	900	830	105.40	1
500	480	1000	1100	162.70	1
560	456	1120	1115	244.50	1
630	580	1260	1350	309.60	1
710	570	1440	1400	394.50	1
800	480	1600	1500	560.00	1



PE100 | SDR 17 | Water PN 10 | Gas 6 Bar

D (mm)	L1 (mm)	R (mm)	L (mm)	Weight (kg)	Box Quantity
50	100	75	170	0.20	1
63	100	95	180	0.30	1
75	100	113	200	0.50	1
90	100	135	220	0.70	1
110	150	165	240	1.10	1
125	150	188	270	1.60	1
140	150	210	300	2.40	1
160	180	240	330	3.40	1
180	188	270	380	4.80	1
200	214	300	430	7.10	1
225	252	338	500	10.80	1
250	262	375	530	13.20	1
280	263	420	550	18.00	1
315	318	473	650	26.40	1
355	301	533	650	33.40	1
400	337	600	730	47.90	1
450	320	900	830	69.40	1
500	480	1000	1100	110.50	1
560	456	1120	1115	138.20	1
630	580	1260	1350	210.00	1
710	570	1440	1400	266.70	1
800	480	1600	1500	395.50	1
900	1050	1800	1800	472.44	1

Every effort has been made to ensure the information in this brochure is correct at the date of issue. Fusion operates a policy of continuous product improvement and range extension and, therefore, reserves the right to modify product specifications in line with market requirements.