

Seamless Bend 30°

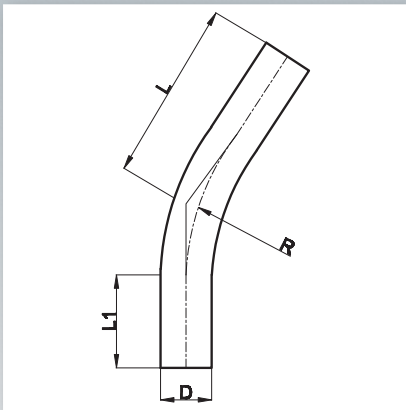

PE100 | SDR 11 | Water PN 16 | Gas 10 Bar

D (mm)	L1 (mm)	R (mm)	L (mm)	Weight (kg)	Box Quantity
50	105	75	170	0.30	1
63	108	95	180	0.40	1
75	119	113	200	0.70	1
90	129	135	220	1.10	1
110	130	165	230	1.70	1
125	150	188	260	2.40	1
140	171	210	300	3.50	1
160	180	240	300	4.70	1
180	180	270	330	6.30	1
200	238	300	420	10.50	1
225	252	338	450	13.30	1
250	301	375	530	19.40	1
280	292	420	530	24.40	1
315	366	473	650	38.80	1
355	355	533	650	49.20	1
400	370	600	690	66.50	1
450	342	900	730	89.50	1
500	582	1000	1100	162.70	1
560	560	1120	1100	244.50	1
630	639	1260	1250	309.60	1
710	570	1440	1350	394.50	1
800	480	1600	1450	480.00	1

PE100 | SDR 17 | Water PN 10 | Gas 6 Bar

D (mm)	L1 (mm)	R (mm)	L (mm)	Weight (kg)	Box Quantity
50	105	75	170	0.20	1
63	108	95	180	0.30	1
75	119	113	200	0.50	1
90	129	135	220	0.70	1
110	130	165	230	1.10	1
125	150	188	260	1.60	1
140	171	210	300	2.40	1
160	180	240	300	3.10	1
180	180	270	330	4.30	1
200	238	300	420	7.10	1
225	252	338	450	9.00	1
250	301	375	530	13.20	1
280	292	420	530	16.60	1
315	366	473	650	26.40	1
355	355	533	650	33.40	1
400	370	600	690	45.10	1
450	342	900	730	58.90	1
500	582	1000	1100	110.50	1
560	560	1120	1100	138.20	1
630	639	1260	1250	210.00	1
710	570	1440	1350	266.70	1
800	480	1600	1450	339.00	1
900	1270	1800	1750	466.45	1

Every effort has been made to ensure the information in this brochure is correct at the date of issue. Fusion operates a policy of continuous product improvement and range extension and, therefore, reserves the right to modify product specifications in line with market requirements.