

Seamless Bend 22°

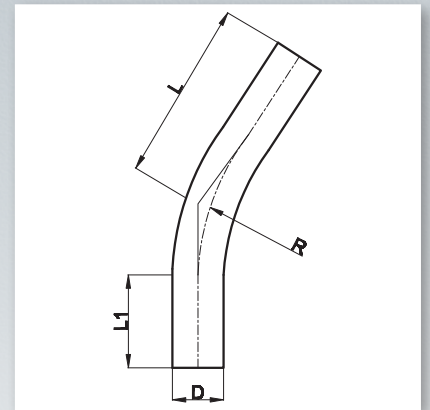

PE100 | SDR 11 | Water PN 16 | Gas 10 Bar

D (mm)	L1 (mm)	R (mm)	L (mm)	Weight (kg)	Box Quantity
50	109	75	170	0.30	1
63	113	95	180	0.40	1
75	125	113	200	0.70	1
90	136	135	220	1.10	1
110	150	165	230	1.70	1
125	156	188	260	2.40	1
140	181	210	300	3.50	1
160	180	240	300	4.70	1
180	194	270	330	6.30	1
200	253	300	420	10.50	1
225	269	338	450	13.30	1
250	320	375	530	19.40	1
280	314	420	530	24.40	1
315	377	473	630	38.80	1
355	383	533	650	49.20	1
400	380	600	660	66.50	1
450	340	900	660	84.30	1
500	564	1000	1000	162.70	1
560	548	1120	1000	203.70	1
630	599	1260	1100	258.00	1
710	570	1440	1300	394.50	1
800	480	1600	1400	480.00	1



PE100 | SDR 17 | Water PN 10 | Gas 6 Bar

D (mm)	L1 (mm)	R (mm)	L (mm)	Weight (kg)	Box Quantity
50	109	75	170	0.20	1
63	113	95	180	0.30	1
75	125	113	200	0.50	1
90	136	135	220	0.70	1
110	150	165	230	1.10	1
125	156	188	260	1.60	1
140	181	210	300	2.40	1
160	180	240	300	3.10	1
180	194	270	330	4.30	1
200	253	300	420	7.10	1
225	269	338	450	9.00	1
250	320	375	530	13.20	1
280	314	420	530	16.60	1
315	377	473	630	26.40	1
355	383	533	650	33.40	1
400	380	600	660	45.10	1
450	340	900	660	55.50	1
500	564	1000	1000	110.50	1
560	548	1120	1000	138.20	1
630	599	1260	1100	175.00	1
710	570	1440	1300	266.70	1
800	480	1600	1400	339.00	1
900	1350	1800	1700	454.85	1

Every effort has been made to ensure the information in this brochure is correct at the date of issue. Fusion operates a policy of continuous product improvement and range extension and, therefore, reserves the right to modify product specifications in line with market requirements.